



7 INCH DIGITAL
MONITOR SYSTEM
Part # SMQ7J



Just View It!®

Please read this manual completely before operating the SYSTEM

A division of
Component Solution Services, LLC.
5660 Twin Branch Dr.,
Mishawaka, IN 46545
www.verityrvs.com



Verity Rear Vision Systems
All rights reserved 2019

Now includes our ADD25F
Heavy Duty Mount



Just View It![®]

www.VerityRVS.com

Verity Rear Vision Systems



8 57394 00719 7



Component Solution Services LLC., offers the **Verity Rear Vision Systems®** to meet any requirements and price point within the trucking, specialty vehicles, and RV industry. Verity Rear Vision Systems® is also home to the Supreme View® line of specialty format systems. Our standard cabled systems offer unparalleled features into the trucking and RV industries. Designed for professional drivers, Verity Rear Vision Systems develops and markets products and applications to transmit video, audio, and data either individually or in any and all combinations. The company has also developed, manufactured, and marketed different kinds of personal and vehicle video cameras, DVRs, and accessories for the commercial transportation, fire/rescue, and marine OEM markets.

**Think safety
First**

**Read our manual before operating
or installing.**

Most likely, your system came preinstalled so the installation section would be for reference.

Thank you for your purchase of our Verity Rear Vision Systems®. When installed and used properly, your SM07J is designed to deliver you years of trouble-free operation. This manual contains important information required to properly install and operate the unit. Verity Rear Vision Systems are designed for quick installation by trained professionals in proper installation environments. Our designs are based on decades of working with vehicle manufacturers.

Verity Rear Vision Systems products are intended to be installed as a supplement and our observation systems and/or products are not intended for use as substitutes for rear-view mirror devices, or for any other standard motor vehicle equipment which may be required to be installed on vehicles by law. Verity Rear Vision Systems products promote improving the vehicle operator's field of view. Our products are no substitute for proper defensive driving techniques, observance of traffic laws and motor vehicle safety regulations.

Installation Location

It is unlawful in most locals for any person to drive a motor vehicle equipped with a television viewer/screen located at any point forward of the back of the driver's seat (or in any location that is visible, directly or indirectly), to the driver while operating the vehicle. Our systems are designed to be used primarily as a rear observation device.

DO NOT OPEN ANY COMPONENT. There are no serviceable parts inside any of the components of the Verity Rear Vision products. Opening the product will break the tamper indicators and void the warranty. Contact our tech support if a problem should arise 574-807-6002. For faster response, fill out a service ticket found on our website tech support section. www.verityrvs.com

WARNING

- ◆ Do not place heavy objects on cables or cover them with carpet or mats.
- ◆ Do not place cables where they can be crushed in any manner.
- ◆ Our systems are designed as a driving aid. Watching videos, broadcasts, DVDs and/or any images other than intended driving assistance cameras is prohibited.

CAUTION

- ◆ To avoid damage to the electronic circuit, stop using this product while doing welding work to the vehicle and/or trailers.
- ◆ Never immerse any component in water, and do not employ spray cleaners. When cleaning, use a damp lint-free cloth only.
- ◆ Connect this unit only to other compatible devices.
- ◆ Although our products have built-in surge and cross polarity protection, make sure all cables are connected properly; improper cable connections may damage the camera and the monitor.
- ◆ Cables should not be allowed to touch hot or rotating parts, such as the engine, ventilator, etc.
- ◆ Do not locate the monitor near heat generating vents or devices.
- ◆ Turn off power to the monitor when connecting the camera.

Monitors are not designed to be waterproof. (Our SM07F waterproof monitor is the exception.) Exposure to water, such as rain, may damage the unit.

SYSTEM FEATURES

MONITOR SPECIFICATIONS

MONITOR SPECIFICATIONS (part# MK07K)

Screen size: 7-inch digital screen (16:9)

Long Life High Resolution: 800 x 480 Pixel (RGB)

System: PAL/NTSC selectable

Contrast: 400:1

Brightness: 450cd/m²

Power supply: DC 12V~24V with reverse polarity protection

Operation temperatures: -30~70C

Storage temperature: -40~80C

2 AV color coded inputs with color coded trigger wires,
auto blue screen if no signal on activated channel

Features: HD sunshade, auto light sensor dimming for buttons and LCD
screen, LED blue light buttons, high quality processor, in-line waterproof fuse
Easy to use OSD menu function via buttons & remote: image delay on time
0~15s, (for side cameras) Mirror/Normal image, multi-language, NEW!

Adjustable guidelines.

1 / 3" COLOR CCD CAMERA SPECIFICATIONS

With Audio and IR TV System: NTSC

Aluminum shelled waterproof camera with hex bolts for insured positioning

Image Type: 1/3 Inch Color CCD Sharp® or equivalent (no cheap off brands)

Horizontal Resolution: 700 TV Lines

Effective pixel: NTSC: 510 (H) x 492(V)

Illumination: 0 Lux (built-in 20 high output IR LED's for night vision)

Viewing angle: 120°

Waterproof: IP69K Shockproof: 10G

Operating temperature: -40°C to +70°C

Power supply: 12V DC (powered by monitor)

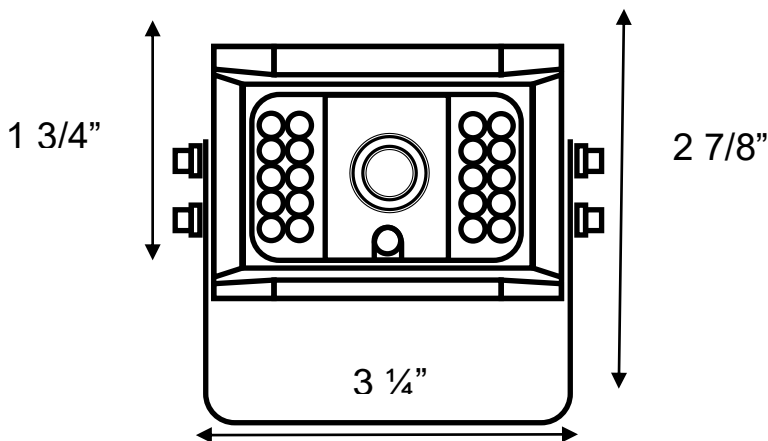

SYSTEM COMPONENTS



7-Inch HD QUAD LCD



I/F Remote



Infrared Weatherproof Camera



65 foot
Camera Cable



13-pin Monitor Cable



Manual



H Mount

SYSTEM COMPONENTS

This monitor can be mounted on the dash and can be mounted on both horizontal and vertical surfaces. Make sure the view is suitable to the driver to observe the images. Take care not to block any necessary viewing area when mounting. Before mounting the system, permanently hook up all connections to ensure proper operation.

Mounting Monitor

1. After determining the monitor location, position the monitor support bracket, mark the bolt hole location, and then drill the holes. Be careful not to drill into any other surface that may be hidden.
2. Attach monitor bracket. Mount the monitor to the support bracket with supplied 4 angle adjustment screws.
3. Connect one end of the power cable (wire) to the proper connections. Connect the other end of the power cable (plug) to the monitor; connect the monitor and the camera with the 13-pin system connecting cable.

Camera Connection

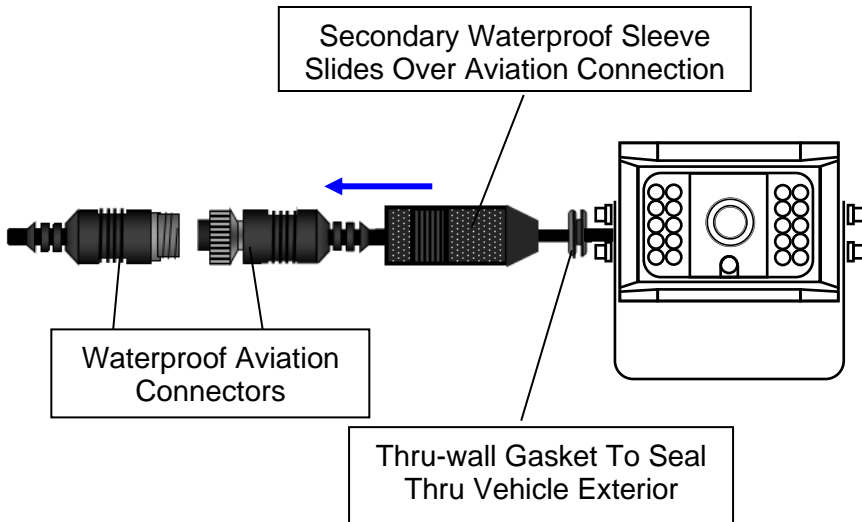

MONITOR / REMOTE OPERATIONS

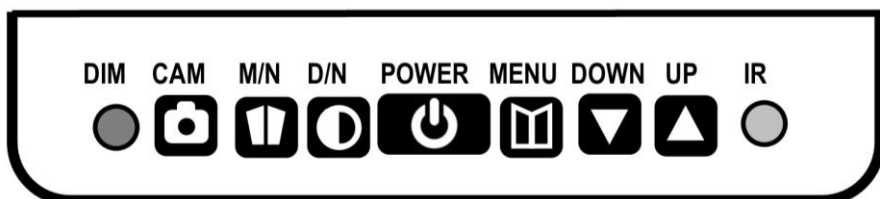

DIM Auto Dimming Photo Cell

CAM Switches between cameras

M/N Mirrored / Normal View

D/N Day / Night screen brightness (Works only when not in auto dim mode)

POWER Power on/off button RED power off / BLUE powered

MENU Activates operational menu

Down Volume DOWN / switches down when in menu

UP Volume UP / switches up when in menu

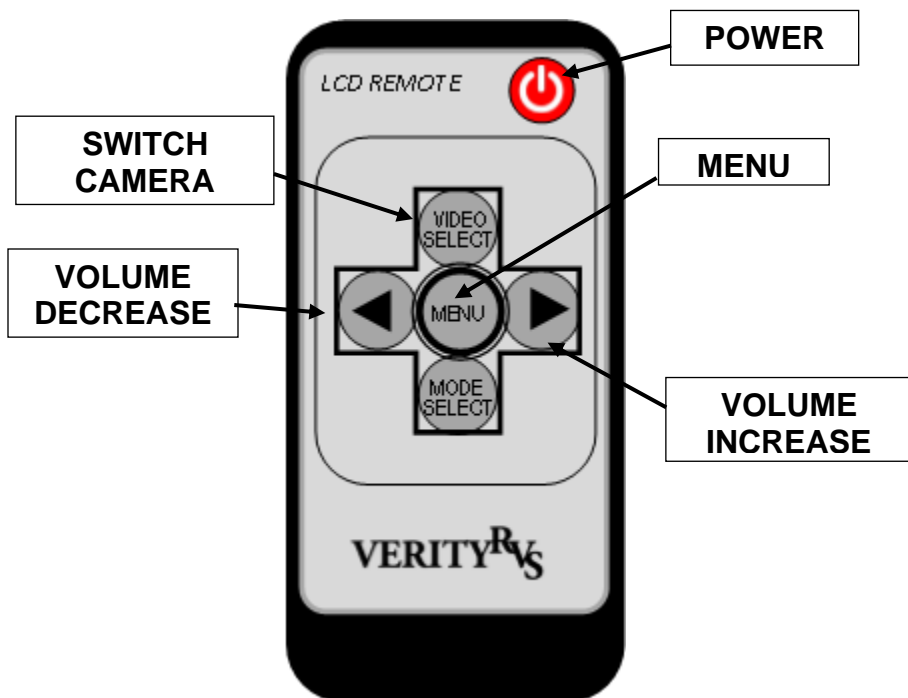

CONNECTION OPERATIONS

Verity Rear Vision Systems Wire Connection Key
4-pin camera connectors & trigger wires

Brown -Camera 1 rear (Brown 4-pin/trigger)

Blue -Camera 2 optional (Blue 4-pin/trigger)

White-Camera 3 rear (White 4-pin/trigger)

Yellow -Camera 4 rear (Yellow 4-pin/trigger)

Red wire to key-on hot (+) 10-32v. DC (fused)

Black wire to GND. (-)

Brown wire to positive backup light for reverse trigger camera 1

BE SURE TO ALIGN 13 PIN CONNECTION

If force is applied to this connection when not aligned, it may damage plug pins and void the warranty.

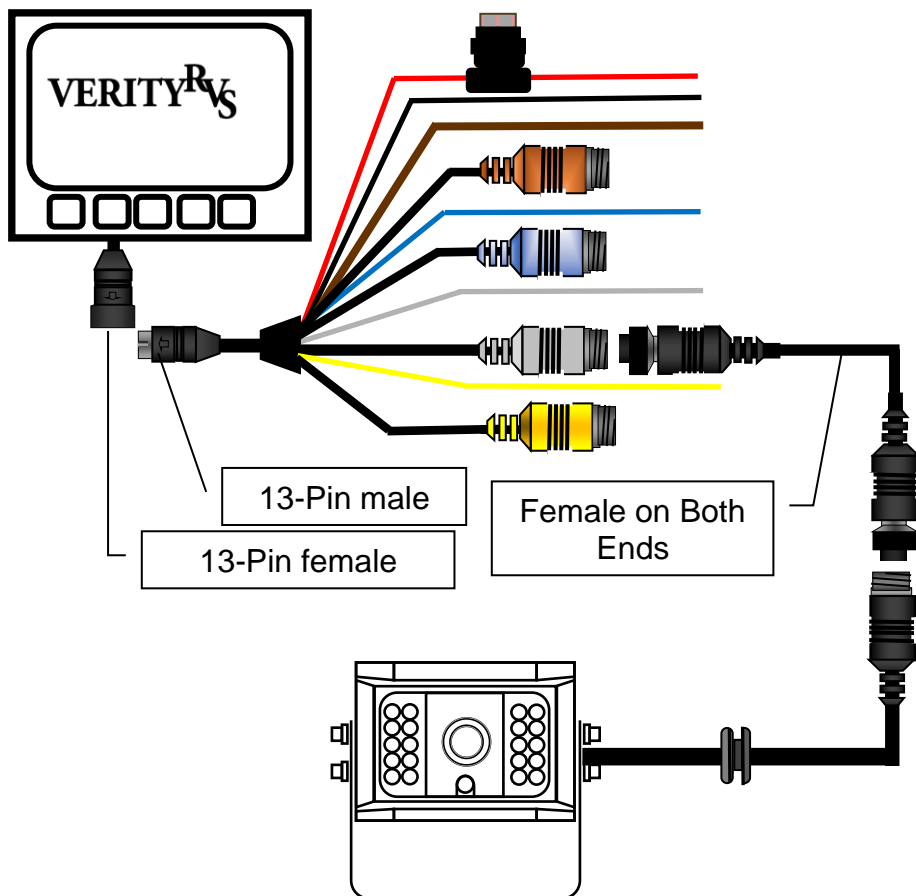

MENU OPERATIONS

Press Menu:

1 time:



Use DOWN / UP arrows to turn the auto dim on/off



2 times:



Use DOWN / UP arrows to adjust contrast



3 times:

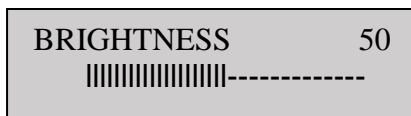

Use DOWN / UP arrows to adjust brightness



4 times:



Use DOWN / UP arrows to adjust color



MENU OPERATIONS

5 times:



Use DOWN / UP arrows to adjust Camera 1 mirrored/normal view



6 times:

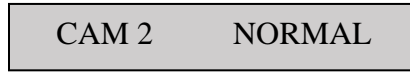

Use DOWN / UP arrows to adjust Camera 3 mirrored/normal view



6 times:

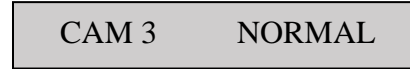

Use DOWN / UP arrows to adjust Camera 3 mirrored/normal view



8 times:

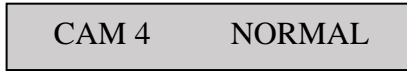

Use DOWN / UP arrows to adjust Camera 4 mirrored/normal view



9 times:



Use DOWN / UP arrows to adjust between 10 languages



10 times:



Use DOWN / UP arrows to adjust camera scan time delay



MENU OPERATIONS

11 times:



Use DOWN / UP arrows to turn on park lines



12 times (if parking lines on):

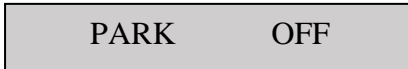

Use DOWN / UP arrows to turn / adjust parking lines Vertically

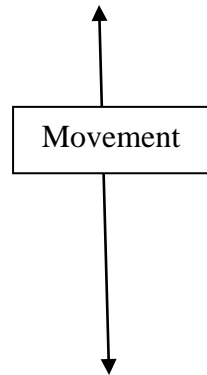
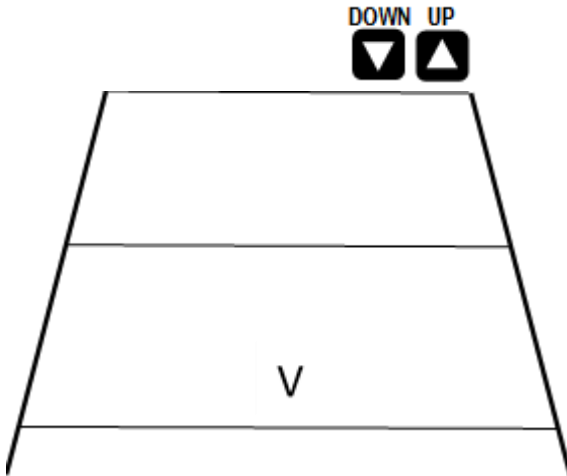

MENU OPERATIONS

13 times (if parking lines on):



Use DOWN / UP arrows to turn / adjust parking lines width

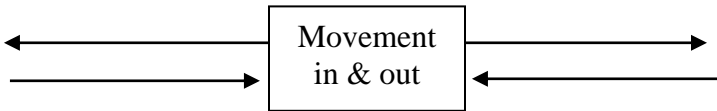
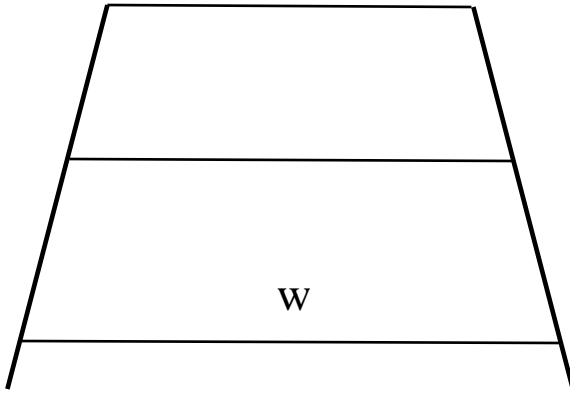

14 times



This will reset factory defaults

Verity Rear Vision Systems
A division of
COMPONENT SOLUTION SERVICES (CSS)
LIMITED ONE (1) YEAR WARRANTY

1. CSS products' warranties are not transferable. The warranties apply to the retail consumer for one (1) year and covers against defects in material and workmanship.

2. Defective components will be replaced or repaired, based on a CSS evaluation of the component. In-bound shipping charges, based on the CSS rate allocated in the RMA (returned merchandise agreement), will be covered once the component has been deemed defective at the CSS warranty facility. The pre-assigned in-bound freight will be supplied upon return of product. All repaired/replaced warranty parts shall be for the remaining duration of the original warranty time period.

3. CSS takes pride in our products and will aid in the processing of your components:

a) All warranty claimants must have consulted our technical support department for trouble shooting and the acquiring of an RMA. Contact can be made via email at tech@verityrvs.com or call 574-807-6002.

b) When the warranty claim is made, the consumer must establish the warranty start dates by presenting documentation regarding the date of retail purchase (e.g., bill of sale). c) Service performed by non-authorized service personnel may void all warranty claims.

d) CSS will make no payments for system removal / system re-installing, mileage allowance, or transportation expenses.

The limited warranty does not cover damage resulting from misuse, accident, modification or alteration to hardware or software, tampering, unsuitable physical or operating environment beyond product specifications, improper maintenance, or failure caused by a product for which CSS is not responsible. There is no warranty for any product with removed or altered identification labels. **CSS DOES NOT PROVIDE ANY OTHER WARRANTIES OF ANY KIND, INCLUDING, BUT NOT LIMITED TO, THE IMPLIED WARRANTIES OR CONDITIONS OF MERCHANTABILITY AND FITNESS FOR A PARTICULAR PURPOSE. SOME JURISDICTIONS DO NOT ALLOW THE LIMITATION OF IMPLIED WARRANTIES, SO THIS LIMITATION MAY NOT APPLY TO YOU.**

4. This warranty gives you specific legal rights, and you may also have other rights that vary from state to state.

Technical Support

A service ticket can be filled out online to supply the quickest service. The service ticket can be easily found on our web site www.verityrvs.com or use the code to the right. Please have the serial number of the system which is found on the back of the monitor when contacting the service department. We take great pride in delivering the most dependable product in the industry. Each item was 100% QC tested and then we randomly recheck another up to 10% before it leaves our hands to you. We have a .034% issue rate with this product.



Email Tech Support: Tech@verityrvs.com

Phone Tech Support: 574-807-6002

Note: if you are a fire/rescue customer in need of tech support after hours or on weekends, leave a message and a technician will return your call as soon as one becomes available.



a division of

Component Solution Services

56600 Twin Branch Drive

Mishawaka, IN 46545

574-807-6002

Toll Free 844-875-4799



We at Verity Rear Vision Systems would like to personally thank you for purchasing our product. Our company strives to supply the best products at a fair price. We care that you enjoy a safe driving experience.

2019 Verity Rear Vision Systems
All content is copy right protected