

Note: system has internal resettable fuse 

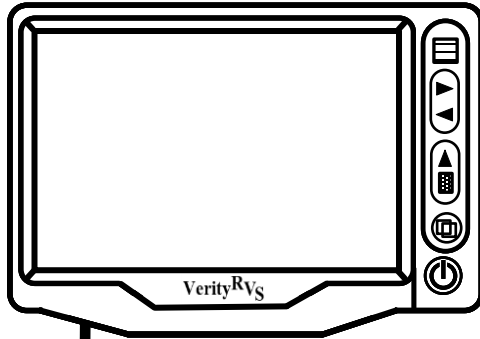

Note: SAE J1292 "suggests" ground wire be white in trucking. We have chosen to utilize a black wire for commonality across our industries served.

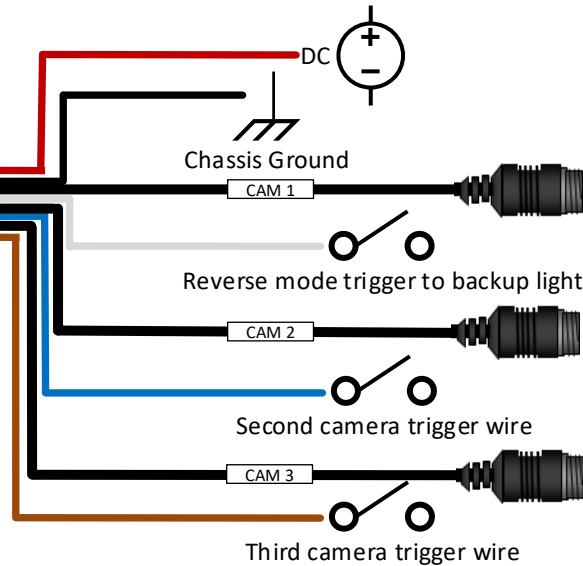

20m – 65 ft. female to male camera cable part# CB020



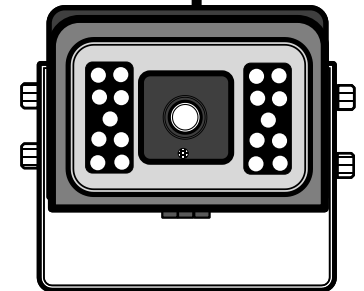

Includes our ADD25F Heavy Duty Mount





Verity Rear Vision Camera Part Number C001C

Wire Connection Key with waterproof 4-pin camera connectors

Red wire to Ignition hot (+) 10-24v. DC (waterproof fuse ) DC 

Black wire to GND. (-) 

White trigger for camera 1 / **Black 4-pin (Cam 1)** - Camera 1 Rear 

Blue trigger for camera 2 / **Black 4-pin (Cam 2)** – Optional Camera 

Brown trigger for camera 3 / **Black 4-pin (Cam 3)** – Optional Camera 

NOTICE

Diagram is for reference purpose only
Subject to change without notice. Not to Scale

Drawing by:
Bill V.
6/2018

**Wiring layout for
Systems SM05C "C" Series
Three Camera Input System**